

# THE WATER RAT

Published by  
"LEANDER" (KINGSTON) SEA SCOUT GROUP

FEBRUARY 1990

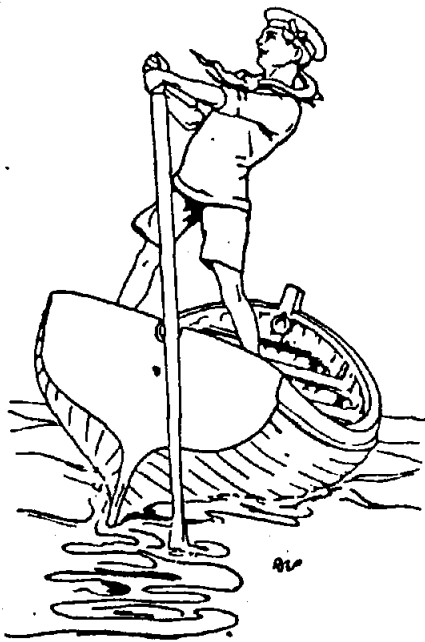

## SKIPPER'S SCRAWL

With the New Year well underway, I am pleased to see all sections forging ahead with a full programme as I hope will be reported in Section's news. Christmas parties are now behind us, but I feel I must congratulate Marion Duffin and her team who worked so hard to put on a marvellous New Year Dinner for the Supporters Social Club. Some 30 sat down to an excellent meal and I was pleased to see not only the 'old guard' but also more parents. Well done also to the two P 1's who waited tables!

The Troop is busy training for the Swimming Gala at Tor Point, but we have also been looking to the future for the National Sea Scout Regatta. If the boys are to get some practice in fibre glass gig pulling, we must complete re-fits on our two fibreglass gigs. Initial estimates are approximately £800. We also need to purchase a marquee/large dining tent, which will be able to accommodate the whole Cub pack since we have two camps planned for Cubs this year. Subject, of course, to funds being available, the Executive committee want to proceed with both items. I would therefore hope that to get sufficient funds, everyone, Beavers, Cubs, Scouts, and Ventures will take part in the District sponsored walk this year (Sunday 18th March). If everyone in the Group gets sponsorship for £10. we can get both tent and the boats repaired.

The progress (or lack of it) on completing building work was also discussed in the December issue, a job list was distributed, but so far we have had no volunteers to undertake these jobs. I would therefore appreciate your call (Tel. 01.399.5846) to let me know what you can do to help get the building finished - be it painting, woodwork etc, etc. It is also essential to get the showers finished as soon as possible - they only need tiles put on the wall - so come on, offers of help please.

Finally, an apology on errors in parts of a sail-last month's Sea Scouting Skills section - it appears a 'gaff' was made (nautical interpretation of gaff will come in a later edition when we cover rigging and spars) It seems only one reader spotted the error so what's happened to all our other experts? A corrected illustration appears this month so please use it to replace last month's issue and compare to note the error. Our thanks to Gordon Dodge for this month's illustration of 'parts of a boat'. Gordon advises me that the Guild expert from Poole has checked the details prior to going to print!

G.S.L. Keith Maund

STOP PRESS! Congratulations to all who took part in the Tor Point National Sea Scouts Swimming Gala, especially to Olly Brown, who is now 1990, National Diving Champion (under 15½ yrs) also to Richard Merry who came 4th in u/14 breaststroke. Final placing not yet known - full report in next edition.

Continued overleaf..

"LEANDER" (KINGSTON) SEA SCOUT GROUP

Headquarters: - 92 Lower Ham Road Kingston upon Thames Surrey  
Telephone: 01-549 6286



DATES FOR YOUR DIARY (continued)

- 11th Feb. - - County Sea Scout Leader Training Day - H.Q.
- 4th/11th/25th March.- County Junior Seaman Badge Course - H.Q.
- 18th March - -District Sponsored Walk -start at 3rd Kingston H.Q.  
                   Scouts, Sea Rangers, Ventures. 09.00hrs (20 Km walk)  
                   Cubs & Ranger Cadets - - 09.30hrs (15 Km walk)  
                   Beavers - - - - 10.00hrs (10 Km walk)

- 29th April -: St. George's Day Parade.
- 16th May(Wed)- Group AGM at H.Q.

\*\*\*\*\*

CHIEF'S CHAT (Report from Scout Leader)

We started the year off by doing our annual Winter camp at Bentley Copse. This took place from the 5th-7th January. There were 5 boys and 3 leaders and this was a good number, as it meant that the leaders had only one or two boys at any one time to look after. The weather was dry until we arrived at Peaslake, as we were doing our hike from Gomshall to the camp site, and from then on it rained. It did not stop us from getting the fire going, and this fire lasted until the Sunday, when we had to put it out by using water. For once we were not alone on the site as there was another group camping, but they used the hut to sleep in (not quite ready for the outdoor life yet!) On the Saturday another group arrived and they were going to build Beaver wacks and sleep in them, as they called their camp the frosty camp. I did inform them that we were not going to get a lot of frost, but a lot of rain was on the way. The rain came around midday, and it never stopped. At 19.00hrs the other group abandoned their camp and went home, 'Too wet to stop out here' was their cry! In the meantime Leander got ready for their night hike. We were the only ones left in the open on the camp-site, which just proves you have got to be made of the right stuff to be in Leander.

Our first meeting took place on Tuesday, 9th January, and normal scout activities was the order of the day. We also had to start practising for the First Aid competition that was due to take place on Sunday, 21st January at Polyapes. We also had been fortunate to be picked for Torpoint this year, so swimming had been taking place every Wednesday and Sunday throughout the month. We came 2nd in the District First Aid competition, with our A team. Congratulations to the A team (led by Tim Sevitt) and also to B team (led by Oliver Brown) which came 4th. As these placings were out of 13 teams who took part, we did very well indeed. This now brings us to the end of January, and our thanks must go to Peter De-Roos for the shooting night he gave us.

I shall soon be calling up the volunteers for the specialised subjects so stand by your phones, Gordon and Nigel!

District Night Hike: The teams have been informed as to the arrangements so Mum, please check with your son to make sure that he knows he is going.

I would like to say a 'big thank you' on behalf of Jen and myself, to Hilary and Marion, and all who helped, for the lovely New Years Dinner Party.

Chief. Mick Chinnock

\*\*\*\*\*

Continued overleaf....

CUBS CAPERS (Report from Cub Leader)

We welcome Martin Tucker and Daniel Simms, who have just joined us this month. We also welcome Michael Baker, who has been very brave and has agreed to come down to Cubs as an instructor. We will be needing more help, as Akela has a new job which will mean he will not be able to come every week, due to shift work. This also gives Rikki a problem of getting to and from Cubs. We will have to see how things go. We may be shouting for help in the near future.

This month we had a Saturday morning with a small group of Cubs, some doing the Map Readers badge, the others doing the Homehelp. We feel that it was a great success, and hope to hold another morning in March. The boys will be given a letter with date and times etc.

We also had a Dutch Evening, with games and food from Holland. We would like to thank Roger Jones for coming to show maps and talk with the Cubs about Holland.

We hope to have 2 Camps this year. One over the May Bank Holiday, and one in September (this one will be a parent and son camp) We will confirm both as soon as possible.

Akela and Rikki

\*\*\*\*\*

BUSY BEAVERS

After the Christmas break, we welcome Ben Williams, James Parker and Robin Bevan, and hope they will be very happy with us. The boys had great fun at least weeks meeting, as Mrs. Randall kindly took a basic First Aid lesson, and brought with her, bandages, slings and plasters. I don't need to tell you how much they enjoyed themselves! We are hoping to arrange another visit from the Road Safety Officer, and also a visit from a dog handler. Please can we re-start the collection of tin foil again as it seems to have died down and it is for a good cause.

Liz.

\*\*\*\*\*

'SOCIAL CLUB SNIP ITS'

On the 3rd January, a group of 20 went to see 'Aladdin' with Cilla Black at Wimbledon Theatre. This was suitably 'tack' as Pantomimes are meant to be, but had a good 'laser' show to liven it up. There were plenty of groaning jokes (rather too many private jokes amongst the cast), but the best of the evening came from the audience, as when Aladdin (Cilla) asked what she should do to punish the wicked Abanazar, better than 'kill him', she was told to 'sing to him'! The evening was good fun, and thanks to Geoff and Daphne Bevis for organising it.

The New Year Dinner Party was on 13th January, and Marion Duffin and Hilary Maund performed miracles below decks in the galley producing a full 4-course meal for 30 people. One of the nautical quirks is that you either have the heating or the ovens- you can't have both. Minds as well as stomach were exercised with seafaring anagrams, where-is-it?, quizzes and puzzles. Thanks also to Roy Bevan for supplying the turkey.

Mitt (Nigel Duffin)

\*\*\*\*\*

Published on behalf of Leander (Kingston) Sea Scout Group by Marv Clark, 34, Lynton Road, New Malden, Surrey)

# PARTS OF WOODEN ROWING BOATS

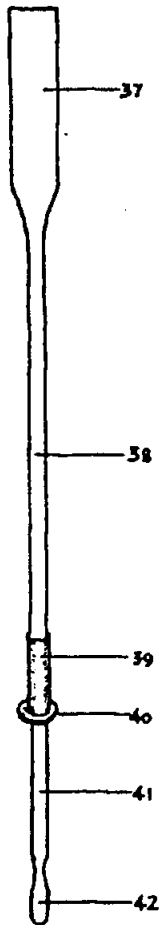
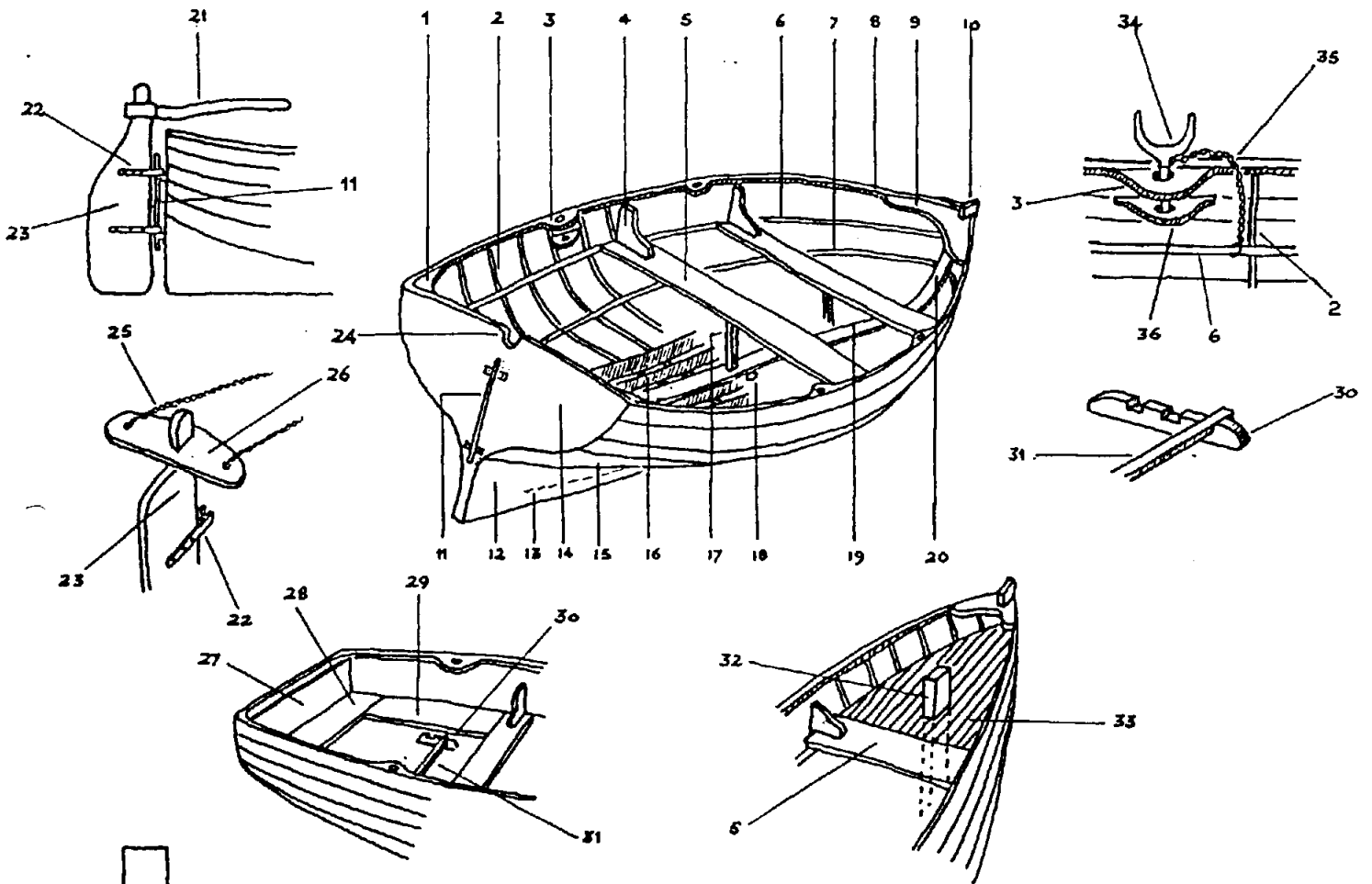

- |    |                  |    |                 |
|----|------------------|----|-----------------|
| 1  | Quarter Knee     | 22 | Gudgeon         |
| 2  | Rib              | 23 | Rudder          |
| 3  | Gunwale swelling | 24 | Sculling Notch  |
| 4  | Knee             | 25 | Yoke Lines      |
| 5  | Thwart           | 26 | Yoke            |
| 6  | Thwart rising    | 27 | Backboard       |
| 7  | Stringer         | 28 | Stern Sheet     |
| 8  | Gunwale (Gunnel) | 29 | Side Bench      |
| 9  | Breast Hook      | 30 | Stretcher Chock |
| 10 | Stem Head        | 31 | Stretcher       |
| 11 | Pintle           | 32 | Samson Post     |
| 12 | Skag             | 33 | Bow Grating     |
| 13 | Keel             | 34 | Crutch          |
| 14 | Transom          | 35 | Crutch Lanyard  |
| 15 | Garboard Strake  | 36 | Crutch Chock    |
| 16 | Bottom Board     | 37 | Blade           |
| 17 | Stanchion        | 38 | Shaft           |
| 18 | Bung             | 39 | Leather         |
| 19 | Hog              | 40 | Stop            |
| 20 | Apron            | 41 | Loom            |
| 21 | Tiller           | 42 | Grip            |

POINTS OF SAILING

IN IRONS



WIND DIRECTION  
↓

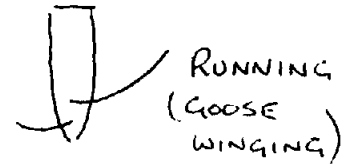

CLOSE HAULED (BEATING)

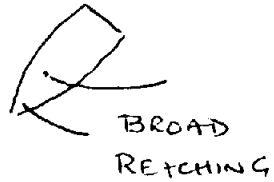
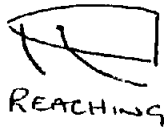

PARTS OF A SAIL

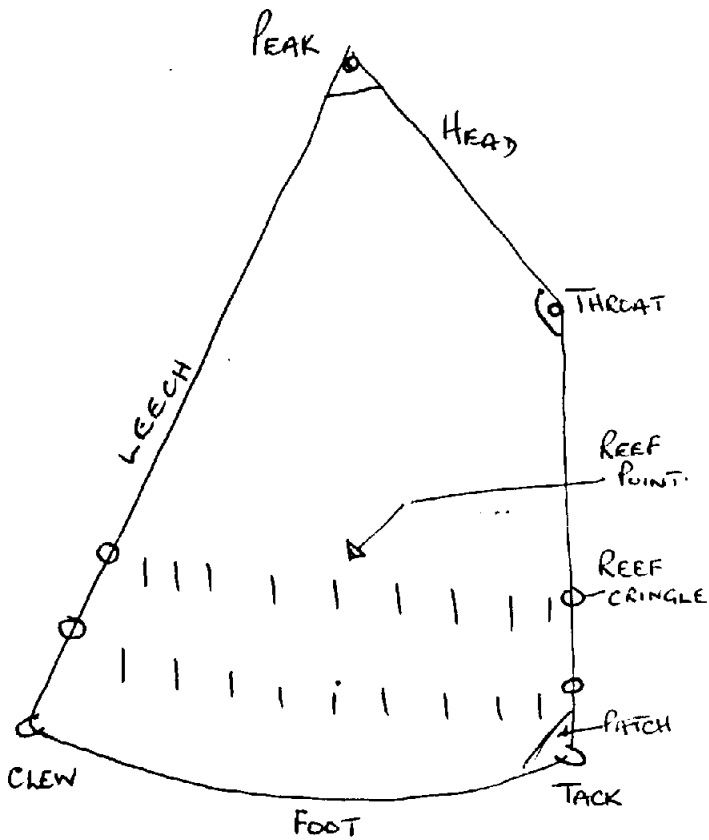

GAFF-HEADED SAIL WITH LOOSE FOOT AND REEF POINTS.

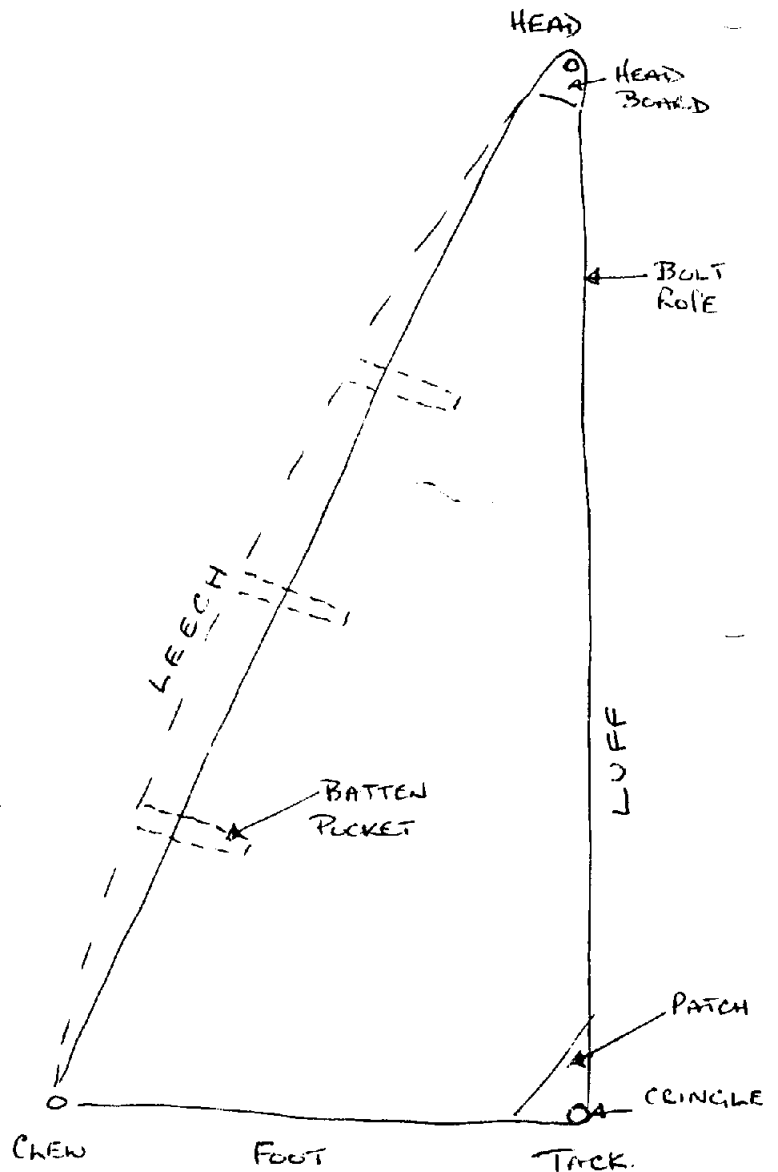

BERMUDIEN SAIL